

SCALPELS AND KNIVES



MICRO SCISSORS



SCISSORS



FORCEPS – ANATOMICS, SURGICALS, MICRO



ANEURYSM VESSEL CLIPS



**ARTERY FORCEPS,
DRESSING AND
SPONGE FORCEPS**



**RETRACTORS,
SELF-RETAINING RETRACTORS,
ABDOMINAL RETRACTORS**



**PROBES,
ASPIRATION**



**DIAGNOSTICS,
ANAESTHESIA**



SUTURE



DRESSING, PLASTER



BONE SURGERY



BONE SURGERY



**THORAX,
CARDIOVASCULAR SURGERY**



**NEUROSURGERY,
LAMINECTOMY**



**STOMACH. INTESTINES,
UROLOGY**



**GYNAECOLOGY,
OBSTETRICS**



OPHTHALMOLOGY



OTOLOGY



RHINOLOGY



**ORAL MAXILLO-
FACIAL SURGERY**



DERMATOLOGY



**STERILISATION,
HYGIENE, STORAGE**



FORCEPS



**Foerster
Sponge Holding Forcep**

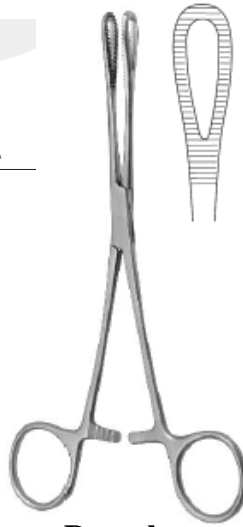
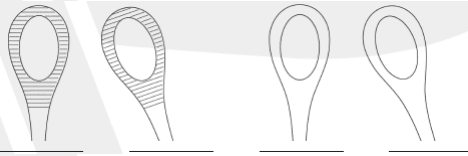

**Rampley
Sponge Holding Forcep**



Crilewood Needle Holder



**Kocher-Ochsner
Haemostatic Forcep
Straight/Curved**

1x2
↔



1x2
↔



**Spencer-Wells
Haemostatic Forcep
Straight / Curved**

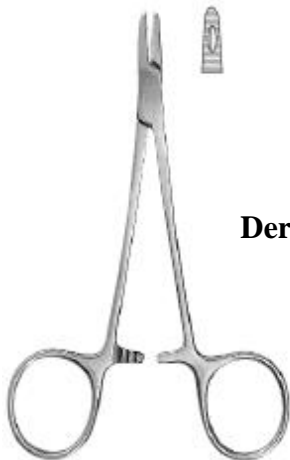
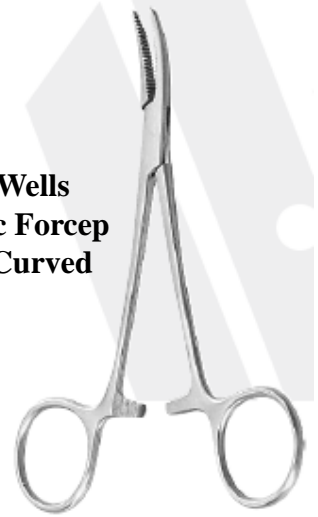

Derf Needle Holder



Serrefine Clip

DISSECTING FORCEPS



TISSUE FORCEPS WITH TOOTHING

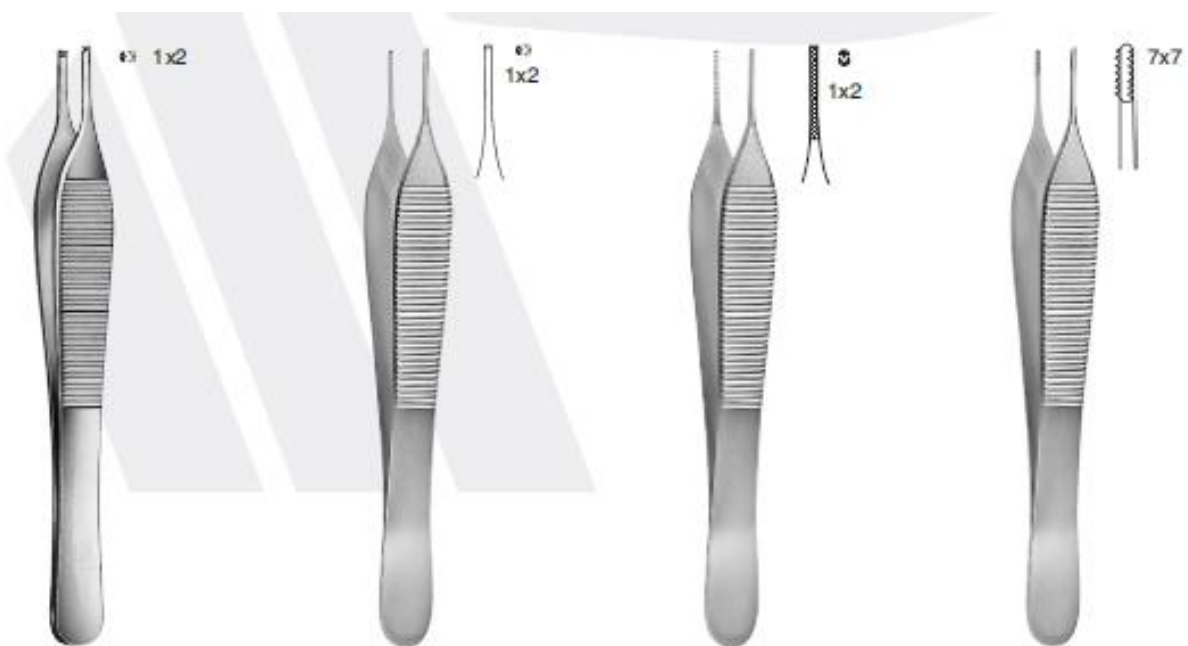
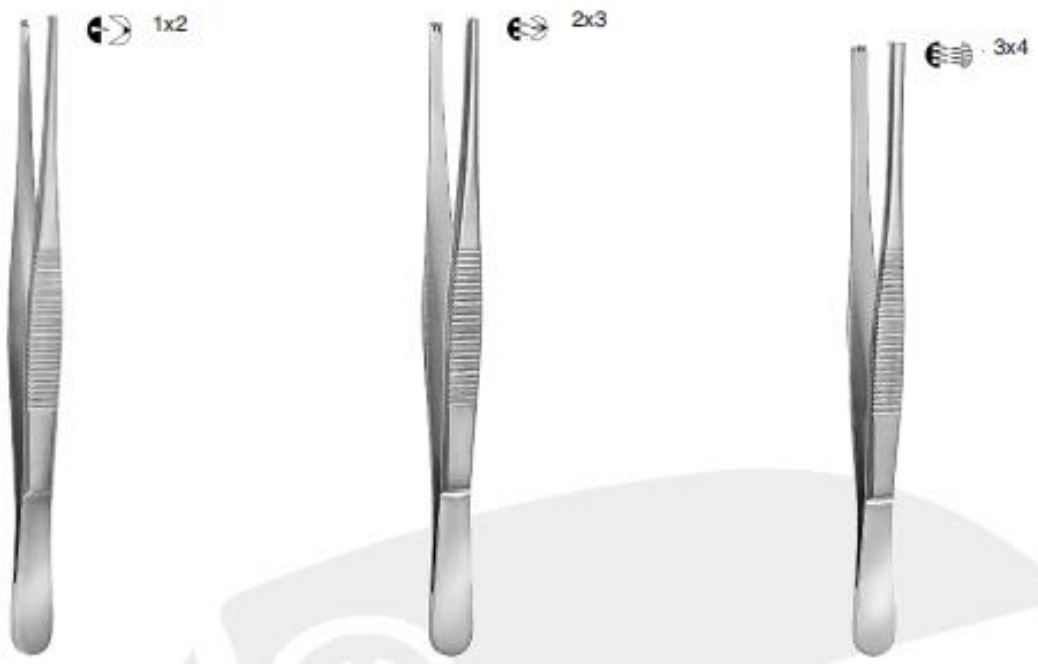

MICRO FORCEPS



1x2



1x2



1x2



0,3 mm



9 mm

0,3 mm x 90°



9 mm

0,3 mm x 45°



9 mm

SURGICAL, DISSECTING SCISSORS



**Strabismus
Delicate Scissor**



**Lexer-Baby
Iris Scissor**

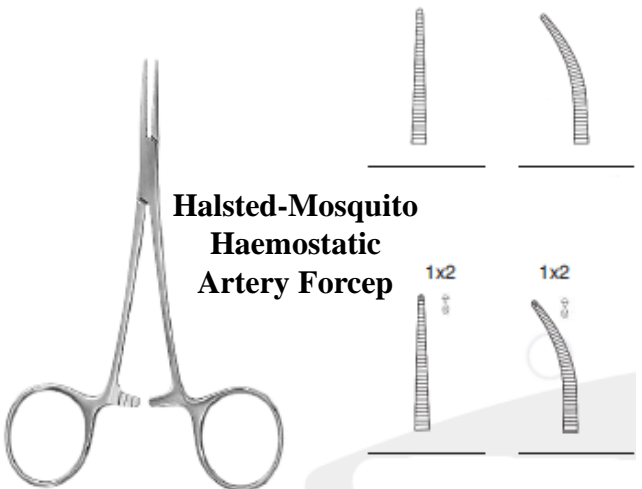

**Halsted-Mosquito
Haemostatic
Artery Forcep**



Surgical Scissors Nurses



**Steven Tenotomy
Delicate Scissor**



**Metzenbaum-Nelson
Dissecting Scissor**

SURGICAL, DISSECTING SCISSORS



Mayo-Stille Surgical Scissor



Kilner Fine Surgical Scissor



Metzenbaum-Fino Dissecting Scissor

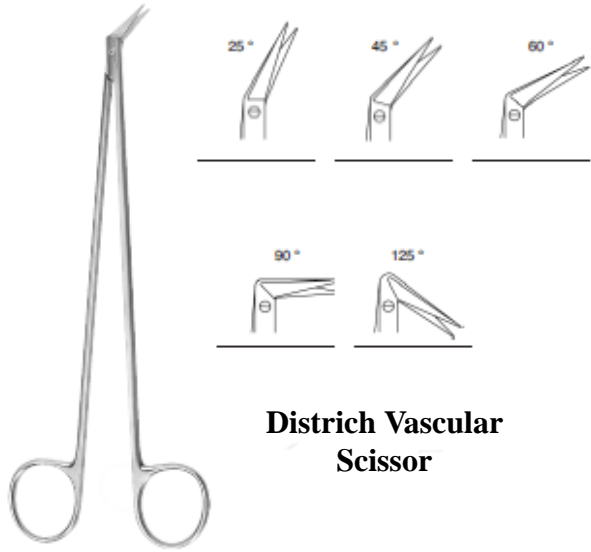

Districh Vascular Scissor

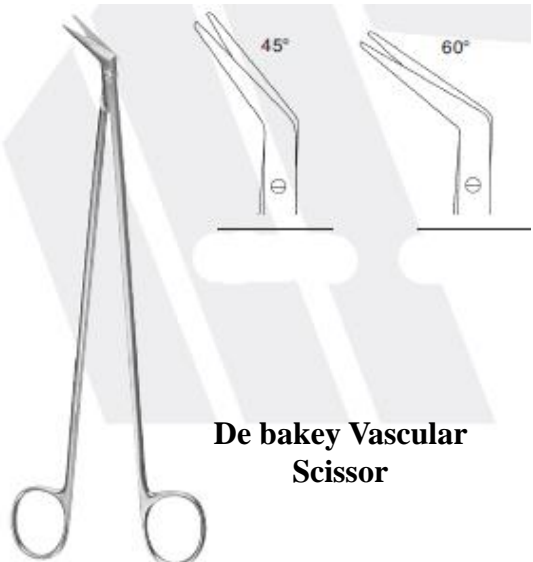

De bakey Vascular Scissor

MICRO SCISSORS, NEEDLE HOLDERS

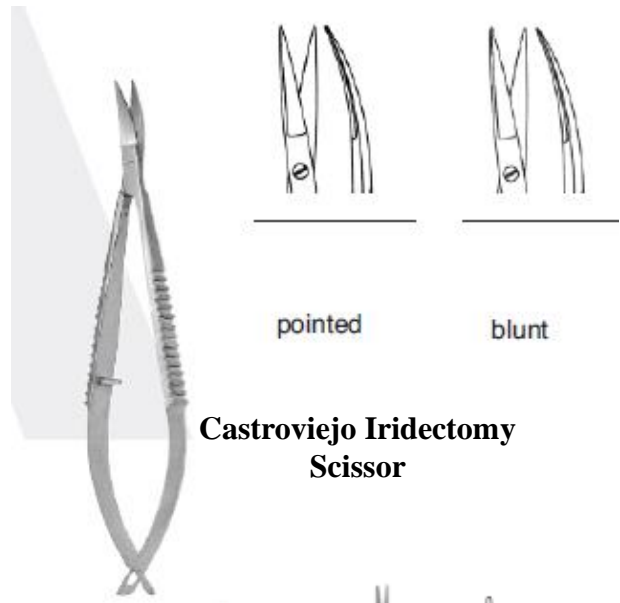

pointed blunt

Castroviejo Iridectomy Scissor

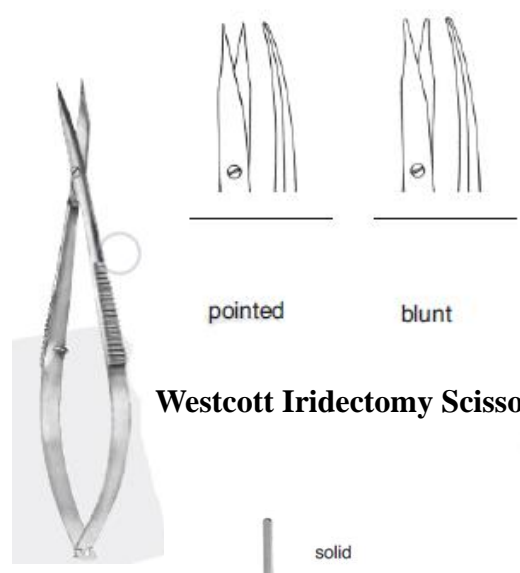

pointed blunt

Westcott Iridectomy Scissor

jaw 1,0 mm



smooth
with ratchet

Barraquer Micro Needle Holder



solid

Scapel Handle No. 3 with cm measurement

with cm - graduation

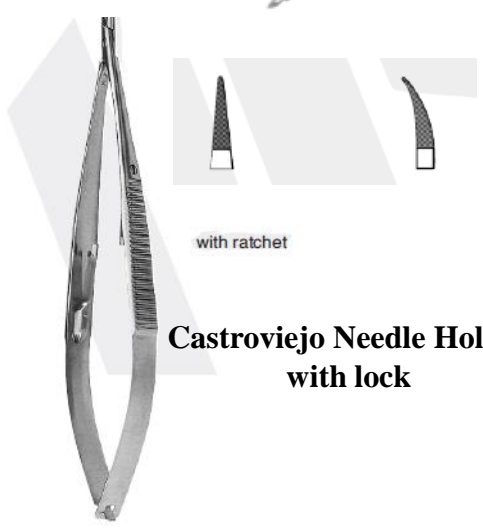

with ratchet

Castroviejo Needle Holder with lock



Lister Bandage Scissor

TUNGSTEN CARBIDE INSTRUMENTS

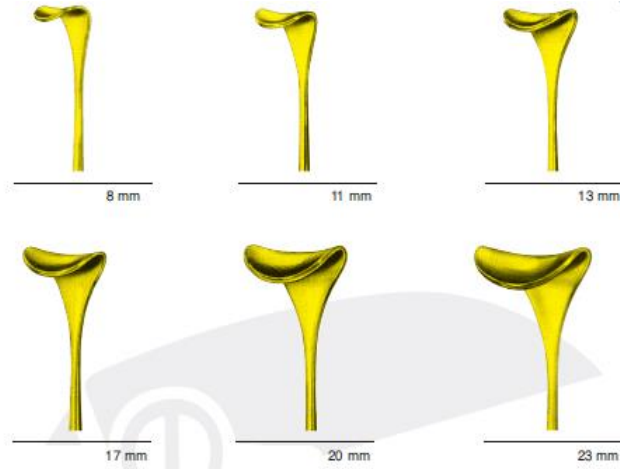
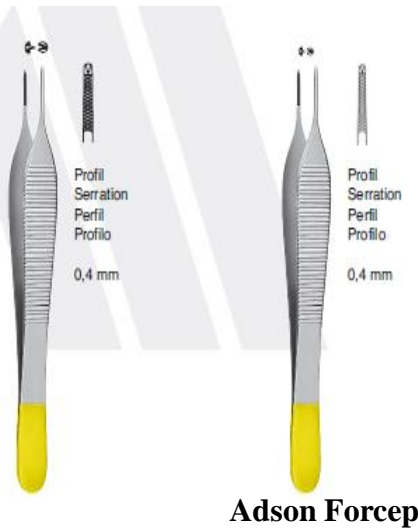
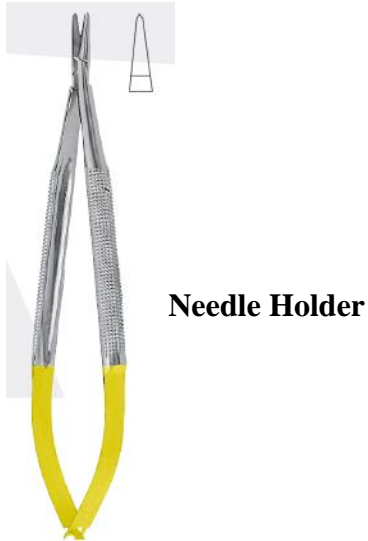

SUPER-CUT SCISSORS

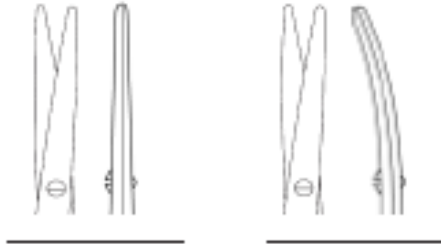

Strabismus Super-Cut Scissor



Metzenbaum-Fino Super-Cut Scissor

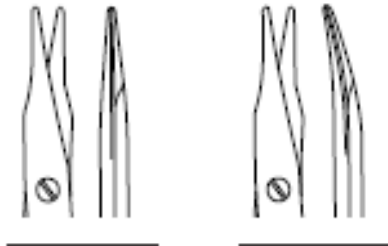

Stevens Super-Cut Scissor

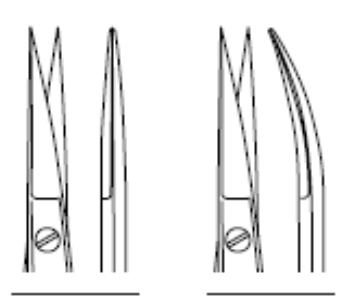

Kelly Super-Cut Scissor

CLAMPS

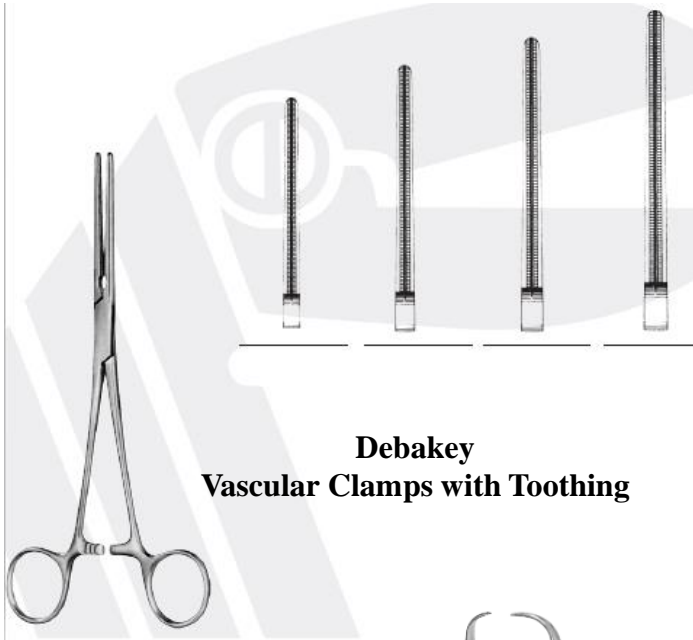

**Debaquey
Vascular Clamps with Toothing**



**Baron Sucker End
Aspirating Instrument**



**Backhaus
Towel Clamp**



**Schaedel
Towel Clamp**



**Magil Suction Tube
Aspirating Instrument**



**Osteotomes
Lambotte**

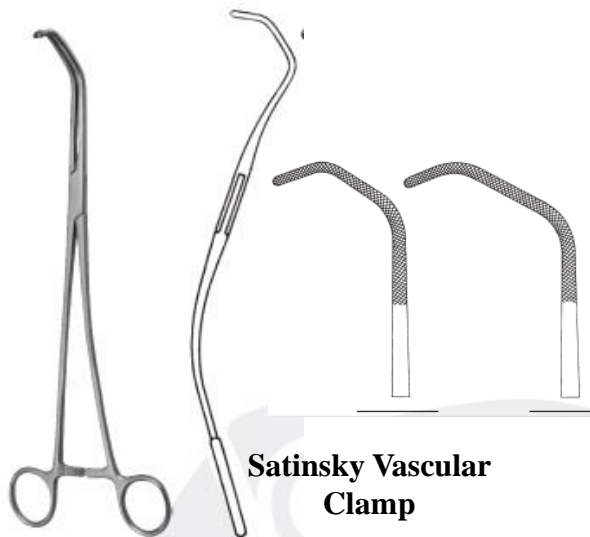

**Satinsky Vascular
Clamp**

RETRACTORS

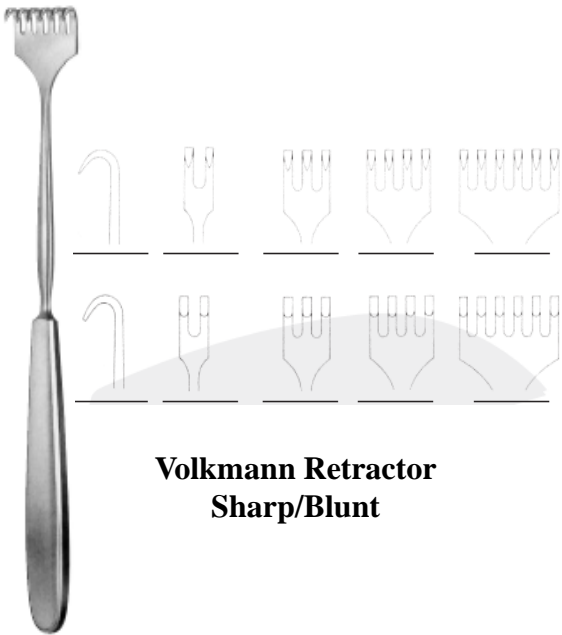

**Volkman Retractor
Sharp/Blunt**

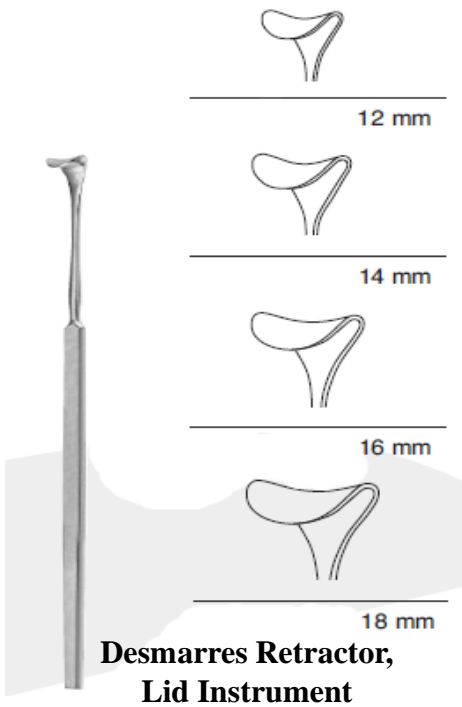

**Desmarres Retractor,
Lid Instrument**



Langenbeck Retractor

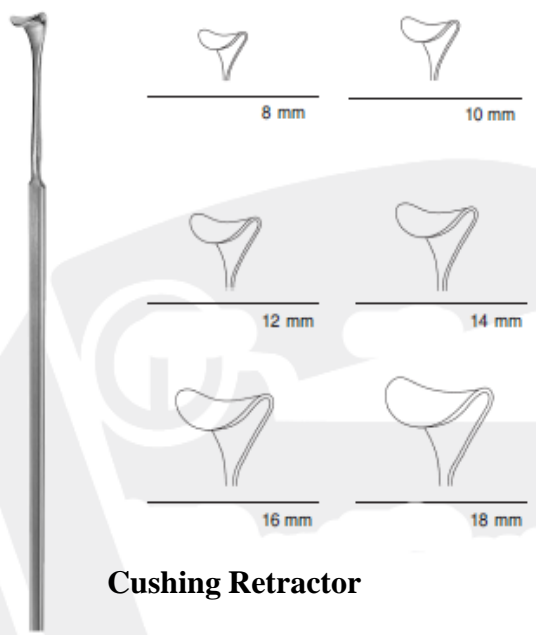

Cushing Retractor

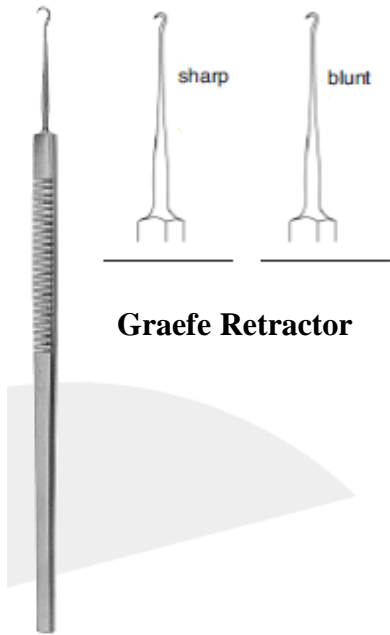

Graefe Retractor

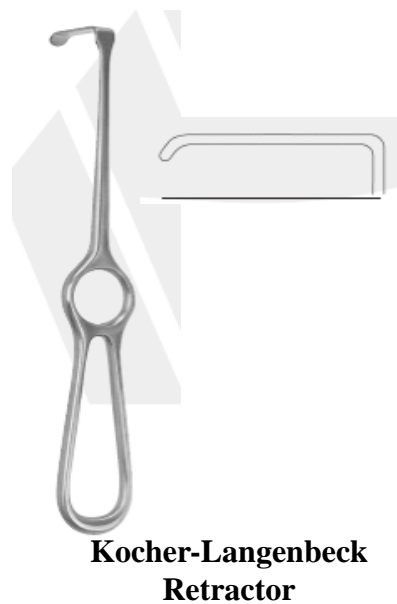

**Kocher-Langenbeck
Retractor**

RETRACTORS



Wetlaner Self-Retaining Retractor

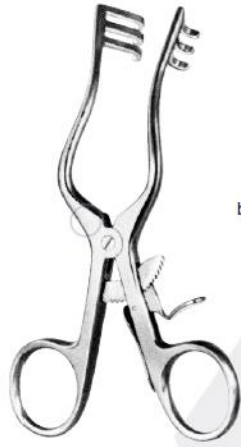
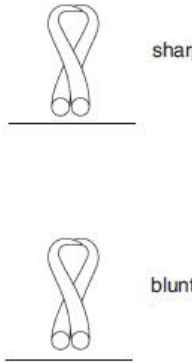

Wetlaner-Wullstein Self-Retaining Retractor

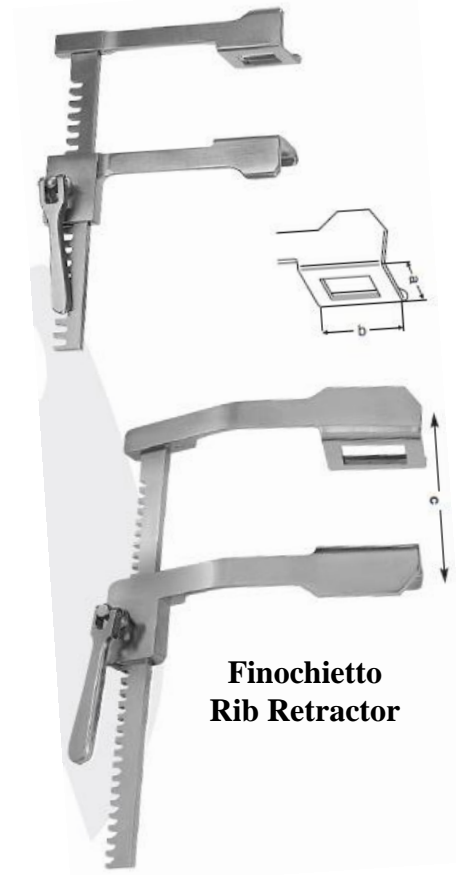
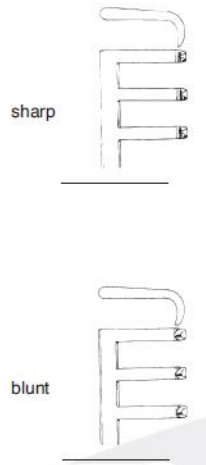

Finochietto Rib Retractor



Deaver Retractor



Adson Self-Retaining Retractor

BONE RONGEURS, CUTTING FORCEPS







Bone Cutting Forcep

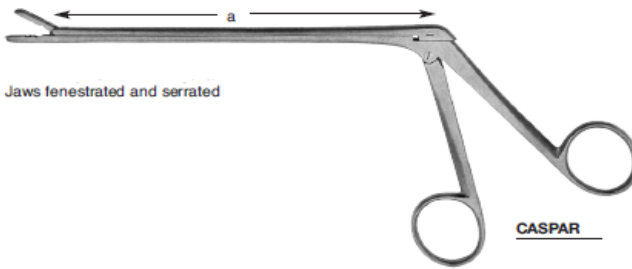

Hartmann Bone Rongeur



Length of shaft	Width of bite				
					
a = 140 mm	2,0 x 12,0 mm	3,0 x 12,0 mm	4,0 x 14,0 mm	5,0 x 14,0 mm	6,0 x 16,0 mm
a = 160 mm					
a = 185 mm					

Laminectomy Rongeur Caspar

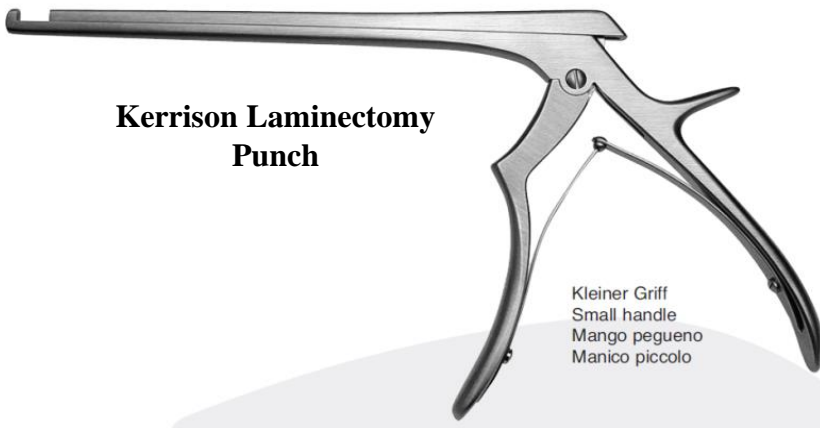

MICRO EAR FORCEPS

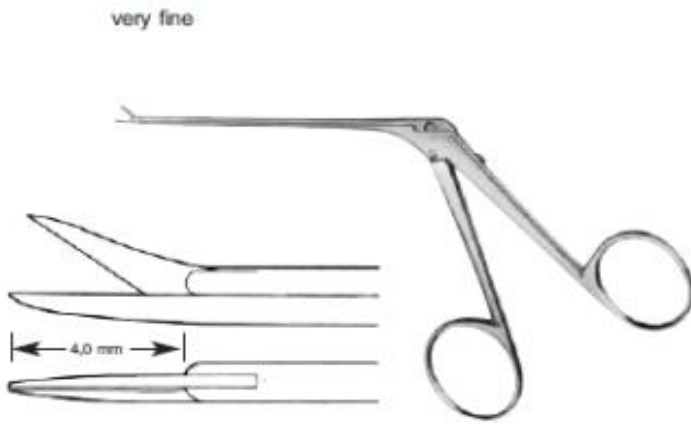

Bellucci Micro Ear Forcep

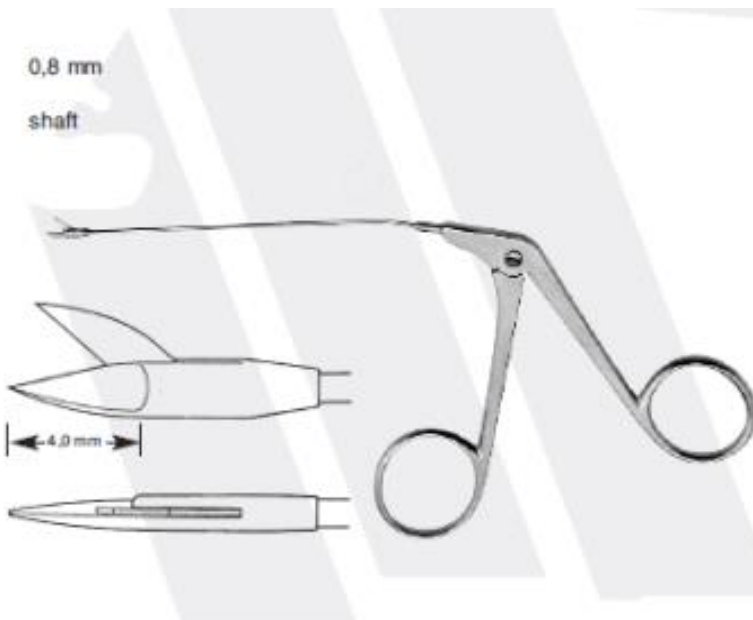
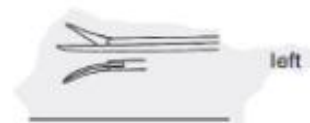

Wullstein Micro Ear Forcep



SKIN HOOKLETS, ELEVATORS

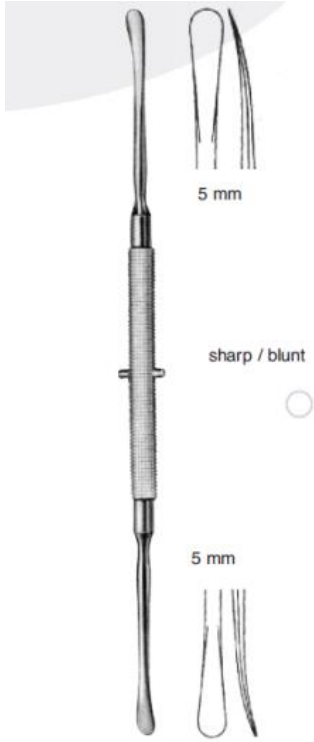

Freer Elevator Double Ended



Fig.1

small curvature



Fig.2

large curvature

Gillies Skin Hook

sharp



Kilner Skin Hook Sharp



Hegar Uterine Dilators Dia. 1 – 30mm



Wilder Lacrimal Dilator



Castroviejo Measuring Caliper

CASTROVIEJO

Measuring Range: 15 mm



CASTROVIEJO

Measuring Range: 20 mm



for hard wires up to 2,2 mm Ø

TC-Wire Cutting Pliers



for hard wires up to 3,0 mm Ø

for hard wires up to 2,5 - 4,0 mm Ø



Spare Part Set: 1 pair of TC-blades, 2 pairs of screws, 1 Allen key

Iron Intern® Single Arm Retractor **SET-UP**

ARH017, ARH022, ARHD22, ARHJ22,
ARH026, ARHJ26



PARTS

Iron Intern® Single Arm
#ARH022-ARM

3/D Swinger Rail Clamp
#3DSREG

3/D Swinger Rail Clamp



Iron Intern® Single Arm

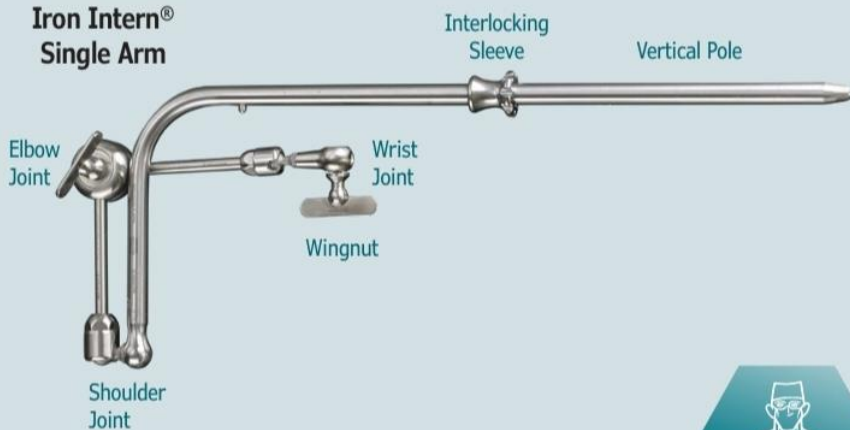

IRON INTERN®

IRON INTERN®

Iron Intern® comes in single and double arms.

Automatic Retractor Holder - ARH 22"

Standard Iron Intern® Single pole with 3/D swinger (U.S. Patents). Vertical pole is 22" long. Iron Intern® is a steady retractor always applying the right pressure, enabling you to position the retractor to your exact requirements.

Automatic Retractor Holder - ARH 17"

Iron Intern® Single pole with 3/D swinger (U.S. Patents). Single pole with 3/D swinger (U.S. Patents). The vertical pole is 17".

Automatic Retractor Holder - ARH 22" Jumbo

Iron Intern® Single pole with 3/D swinger (U.S. Patents). Vertical pole is 22" long.

Jumbo Iron Intern® is specially designed for Bariatric procedures. Shoulder and elbow joints are larger. Larger joints make the instruments stronger and more resistant to applied pressure.

Iron Intern® lends an extra hand in surgery.

Hydra Double Arm

Hydra 22" Iron Intern® (U.S. Patent) double arm allows the surgeon to use two arm holders instead of one. Includes:

- Hydra Pole
- 3/D Swinger
- Hydra Yoke

Hydra Jumbo Double Arm

Jumbo Hydra 22" Iron Intern® is especially designed for Bariatric procedures. Larger joints make the instrument stronger and more resistant for applied pressure.

Hydra Yoke

Hydra Yoke is used in Stieber Rib Grip Kit. Attaching the Hydra Yoke to the Lees Center Platform which is located on the Horizontal Bar, gives a surgeon the ability to use two additional arms with that system.

Cowan Gripper

May be used in many procedures. It is an articulated arm which attaches with a C clamp. It may be attached to not only the Iron Intern® system but to other systems, for example a flat ring surgical system.



IRON INTERN® FOR LAPAROSCOPIC SURGERY

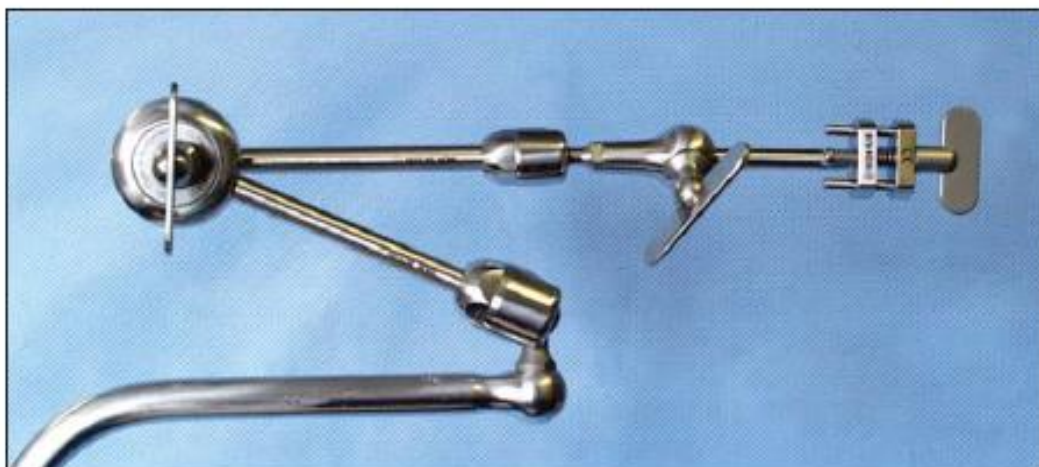

ARH 22"
with LC1 Greenstein Gripper

The Iron Intern® is helpful in general, bariatric, and transplantation surgery. The Iron Intern® is adapted for laparoscopic surgery with the use of the Greenstein Grippers and the Nathanson Hook Liver Retractors and other laparoscopic instruments.



Hydra 22"
with LC1 and LC2



ARH 22"
with the Nathanson Liver Retractor,
medium size

Fields of Surgical

Application:

- General
- Laparoscopic
- Bariatric
- Plastic
- Colon-Rectal
- Vascular
- Gynecology
- Transplantation
- Urological
- Pediatric
- Orthopedics
- Thoracic
- Otolaryngology
- Oral
- Maxillo-Facial
- Veterinary



A 3/D Swinger (rail clamp) permits complete versatility of positioning at the site of fixation to the operating table. The 3/D swinger allows the bar to be tilted from side to side 180 degrees. With the Iron Intern®, a simple adjustment of the 3/D Swinger permits rotation of the long bar up to 360 degrees.

B The Vertical Pole allows you to adjust the length of the main support of the articulating mechanical arm by locking it at your required

position and tightening the 3/D Swinger on the rail.

C Iron Intern® arm functions like a human arm with a shoulder, elbow, and wrist joint. Releasing and locking the wingnut at the elbow joint locks all three. This allows surgeons to adjust the arm to any required position.

The wrist joint holds our large selection of retractors for specific surgery needs. The Universal "Gemma" Connection Clamp (G9) makes using other brand name retractors possible.

